

# CentronicPLUS

## VC420 PLUS

en

### Assembly and Operating Instructions

#### Flush-mounted radio receiver

Important information for:

- Fitters / • Electricians / • Users

Please forward accordingly!

These instructions must be kept safe for future reference.

4036 630 149 0d 19/01/2024

Becker-Antriebe GmbH  
Friedrich-Ebert-Straße 2-4  
35764 Sinn/Germany  
info@becker-antriebe.com  
www.becker-antriebe.com



**BECKER**  
for you. forever.

# Table of contents

General .....	4
Licensing information for open source software.....	5
Warranty .....	5
Safety instructions .....	6
Intended use .....	7
Explanation of displays and buttons.....	8
Explanation of functions .....	9
Wiring .....	14
Compatible Centronic transmitters .....	15
Switching between operating modes .....	16
Resetting the operating mode .....	17
Commissioning with a CentronicPLUS transmitter .....	18
Explanation of symbols .....	18
Programming the CentronicPLUS transmitter .....	19
Selection of the receiver for the setting mode .....	22
Changing direction of rotation via the transmitter .....	24
Adding additional transmitters to the installation .....	25
Setting the travel path.....	26
Deleting the travel path .....	28
Intermediate positions I + II.....	29
Manually adjusting the slat position.....	31
Switching actuator operating mode.....	32
Commissioning with a Centronic transmitter.....	34
Explanation of symbols .....	34
Programming the Centronic transmitter .....	34
Changing direction of rotation via master transmitter.....	37
Deleting transmitters .....	38
Overwriting the master transmitter .....	39
Setting the travel path with a Centronic transmitter.....	41
Deleting the travel path with a Centronic transmitter .....	43
Intermediate positions I + II.....	43
Switching actuator operating mode.....	45
Additional functions with CentronicPLUS / Centronic .....	46
Programming the run times .....	46
Deleting the run times with a CentronicPLUS transmitter.....	47
Deleting the run times with a Centronic transmitter.....	47
Activating / deactivating the run times with a CentronicPLUS transmitter .....	48
Activating / deactivating the run times with a Centronic transmitter .....	48



Restoring the factory settings for the radio programming.....	49
Disposal .....	49
Technical data .....	50
What to do if...?.....	51
Simplified EU declaration of conformity.....	52

# General

The radio receiver, delivered ex works, converts radio signals into control signals. A wired drive can be radio-controlled using the radio receiver. The radio receiver can be controlled with all transmitters in the CentronicPlus range of control units and with various transmitters in the Centronic range of control units (see Compatible Centronic transmitters [► 15]).

Please observe these Assembly and Operating Instructions when installing and setting up the equipment.

## Explanation of pictograms

	<b>CAUTION</b>	CAUTION indicates a hazardous situation which, if not avoided, could result in injury.
	<b>ATTENTION</b>	ATTENTION indicates measures that must be taken to avoid damage to property.
		Denotes user tips and other useful information.

# Licensing information for open source software

This device uses free/open source software.

The licence texts are enclosed with the product in the licence documentation, which can be identified by the following symbol:



The licence texts for the licensed software being used can be downloaded from [www.becker-antriebe.com/licenses](http://www.becker-antriebe.com/licenses).

## **Written request for the licence texts:**

Becker-Antriebe will, on request, provide the licence texts for the licensed software being used at cost price, either on a USB stick or a similar data carrier. Please send an email to the following email address for more information: [licenses@becker-antriebe.com](mailto:licenses@becker-antriebe.com)

## Warranty

Structural modifications and incorrect installation which are not in accordance with these and our other instructions can result in serious injuries, e.g., crushing of limbs. Therefore, structural modifications may only be carried out with our prior approval and strictly in accordance with our instructions, particularly the information contained in these Assembly and Operating Instructions.

Any further processing of the products which does not comply with their intended use is not permitted.

The end product manufacturer and fitter have to ensure that all the relevant current statutory, official and, in particular, EMC regulations are adhered to during utilisation of our products, especially with regard to end product manufacture, installation and customer advice.

# Safety instructions

The following safety instructions and warnings are intended to avert hazards and to prevent property damage and personal injury.

## General information

- Always comply with regulations of local energy supply companies as well as VDE 100 provisions for wet and damp rooms during installation.
- Only use in dry rooms.
- Only use unmodified original parts from the control unit manufacturer.
- Observe all pertinent country-specific regulations.
- Keep people out of the system's range of travel.
- If the system is controlled by one or several appliances, the system's range of travel must always be visible during operation.
- Keep children away from control units.



### Caution

- **Risk of injury due to electric shock.**
- **Connections to the 230 V mains must always be performed by a specialist.**
- **Disconnect the connecting cable from the power prior to installation.**
- **When connecting the control cables , only use cables with sufficient electrical strength.**

## Intended use

The radio receiver described by the present instructions must only be used for the operation of roller shutter, awning, blind and lighting control units. Installing several Centronic / CentronicPLUS devices in the same connection socket is not permitted.

- Please note that radio-controlled systems may not be used in areas with a high risk of interference (e.g. hospitals, airports).
- The remote control is intended solely for use with equipment and systems in which malfunctions in the transmitter or receiver would not pose any risk to persons, animals or property, or which contain safety devices to eliminate such risks.
- The operator is not protected from interference from other telecommunications systems and terminal equipment (e.g. even from radio-controlled systems which are properly operated in the same frequency range).
- Only connect radio receivers to devices and systems approved by the manufacturer.





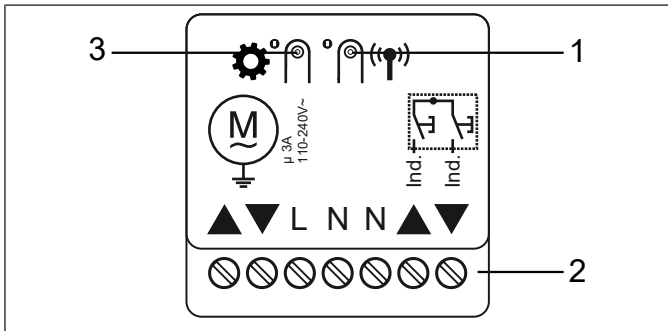

- **Ensure that the control unit is not installed or operated close to metal surfaces or magnetic fields.**
- **Radio-controlled systems transmitting on the same frequency may cause reception interference.**
- **Note that the range of the radio signal is limited by legislation as well as by design.**

# Explanation of displays and buttons

















1 Programming button

2 Connecting terminals

3 Mode button	Roller shutter (factory setting)	 1x
	Sun protection	 2x
	Venetian blind	 3x
	Switching actuator	 4x













# Explanation of functions

Explanation of symbols	
	Ascend / retract
	Descend / extend
	Ascend / retract disabled
	Descend / extend disabled
 or 	Centronic: The drive stops after releasing the respective travel button
	Centronic PLUS: The drive stops 5 s after pressing the respective travel button
	Wind
	Wind threshold value
	Sun
	Sun threshold value
	Rain
	No rain
	Sensor loss
	Intermediate position I
	Intermediate position II





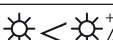













## Roller shutter operation

By pressing a travel button, the roller shutter moves to the set limit position.

	Delay time	Response
<b>Behaviour in wind</b>		
		▼
	15 min.	Automatic
		
<b>The receiver retracts when it rains</b>		
		▲
	15 min.	Automatic
<b>The receiver does not react to rain</b>		
		Automatic
		Automatic
<b>The receiver extends when it rains</b>		
		▼
	15 min.	Automatic
<b>Automatic</b>		
	3 min.	▼*
	15 min.	▲

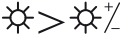

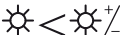













## Awning operation

By pressing a travel button, the awning moves to the set limit position.

	Delay time	Response
<b>Behaviour in wind</b>		
		
	15 min.	Automatic
	60 min.	
<b>The receiver retracts when it rains</b>		
		
	15 min.	Automatic
<b>The receiver does not react to rain</b>		
		Automatic
		Automatic
<b>The receiver extends when it rains</b>		
		
	15 min.	Automatic
<b>Winter mode</b>		
		
<b>Automatic</b>		
	3 min.	
	15 min.	

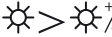
## Venetian blind operation

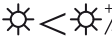
In venetian blind operation, the current slat tilt is saved as well as the intermediate positions I + II. The saved tilt is applied when moving to the respective intermediate position.

	Delay time	Response
<b>Behaviour in wind</b>		
		
	15 min.	Automatic
	60 min.	
<b>The receiver retracts when it rains</b>		
		
	15 min.	Automatic
<b>The receiver does not react to rain</b>		
		Automatic
	15 min.	Automatic
<b>The receiver extends when it rains</b>		
		
		Automatic
<b>Automatic</b>		
	3 min.	
	15 min.	

## Switching actuator operation

Pressing a travel button switches the consumer **on**, and the stop button on the transmitter switches it **off**. In switching actuator mode, the device behaves differently to the previous operating modes.

## Outputs <sup>(M)</sup>

Connect the drive to the outputs of the device. The arrows on the device show the direction in which the drive turns.

## Individual inputs <sup>▲ ind.</sup><sub>▼ ind.</sub>

These connecting terminals are intended for an additional button.

Mode	Operation	Duration	Function
Roller shutter / sun protection / venetian blind	Button actuation	> 0.5s	Approaching respective limit position
Roller shutter / sun protection / venetian blind	Push button (while driving)	< 0.5s	STOP
Venetian blind	Push button (when still)	< 0.5s	Touch mode
Roller shutter / sun protection / venetian blind	Double-tap	Within 1s	Approaching respective intermediate position
Switching actuator	▲ ind.	-	ON/OFF sequence
Switching actuator	▼ ind.	> 0.5s	ON
Switching actuator	▼ ind.	< 0.5s	OFF



In switching actuator operating mode, a regular switch can be used for operation.

# Wiring



## Caution

- Risk of injury due to electric shock.
- Connection may only be performed by a qualified electrician!
- The device only offers back-of-hand protection, not touch protection.
- If two or more drives are going to be operated via the radio receiver, the drives must be decoupled by relay controls. There is no need for decoupling in the case of our drives with electronic limit switching.
- Always take into account the device switching current.

## Attention

Make sure that the drive limit positions have been set.

1. Connect the device as follows:

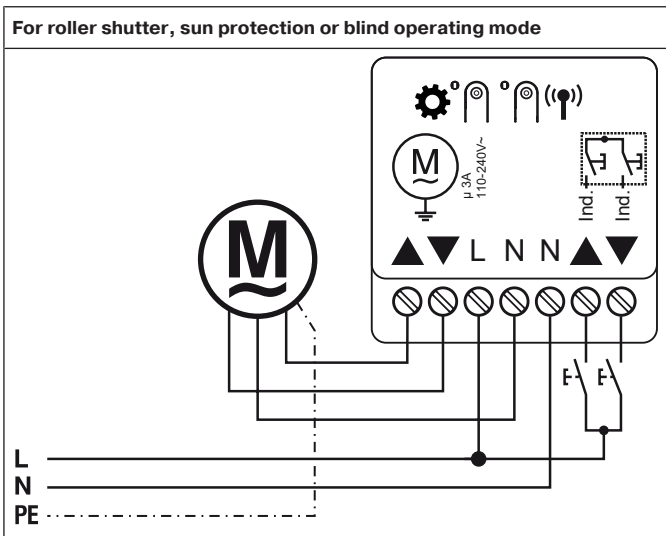

## For switching actuator operating mode

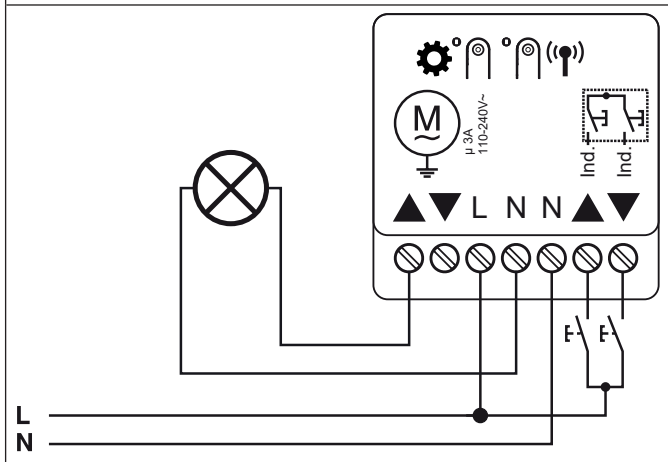

2. When the power is switched on, the device confirms by briefly switching in the UP direction.
3. Set the operating mode as described in the chapter Switching between operating modes [► 16].
4. Programme a transmitter into the receiver.

## Compatible Centronic transmitters

All CentronicPlus receivers can be operated with the Centronic transmitters listed in the Centronic/CentricPlus compatibility table at



**[www.becker-antriebe.com/downloads](http://www.becker-antriebe.com/downloads)**

As two fundamentally different radio technologies are linked in this case, the full performance of the CentronicPlus radio control system is not available in this combination. When using the Centronic transmitter with CentronicPlus receiver, the range performance may be reduced under certain circumstances. A Centronic transmitter cannot process feedback from the CentronicPlus receiver. The full performance of CentronicPlus is only achieved in combination with CentronicPlus transmitters, receivers and sensors, as only then will an intelligent, bidirectional system be automatically created.

## Switching between operating modes



The running time, tilt, intermediate positions, direction of rotation, programmed transmitter and installation data are deleted when changing operating mode.

	<p>Briefly pressing the mode button on the radio receiver causes the adjacent LED to flash orange to indicate the current operating mode.</p> <ul style="list-style-type: none"><li>▶ LED flashes 1x: Roller shutter</li><li>▶ LED flashes 2x: Sun protection</li><li>▶ LED flashes 3x: Venetian blind</li><li>▶ LED flashes 4x: Switching actuator</li></ul>
	<p>Keep the mode button pressed down to switch to the next operating mode. Briefly pressing the mode button again switches to the next operating mode, and so on. Once the required operating mode has been selected, wait a moment until the LED next to the mode button confirms the programming by lighting up green.</p>



## Resetting the operating mode



The running time, tilt, intermediate positions, direction of rotation, programmed transmitter and installation data are deleted when resetting the operating mode.











Press the mode button until the adjacent LED starts to flash red and then lights up green. Release the button as soon as the LED lights up green.

- ▶ The operating mode has been reset and the radio receiver switches to programming mode.

# Commissioning with a CentronicPLUS transmitter

## Explanation of symbols

Explanation of symbols	
	Up/retract button
	STOP button
	Down/extend button
	Programming button (on the transmitter)
	Programming button (on the radio receiver)
	Mode button (on the radio receiver)
	LED ring on the transmitter (only when using a CentronicPlus transmitter. Feedback is not sent to the transmitter when using a Centronic transmitter)
	Receiver confirms once or multiple times by switching outputs or by the mode LED illuminating
Operating modes	
Normal mode	Control of selected receiver / channel
Receiver selection	Selection of the required receiver and channel allocation
Setting mode	Commissioning and administration of selected receivers

# Programming the CentronicPLUS transmitter



## Caution

- Risk of injury due to electric shock.
- Connection may only be performed by a qualified electrician!
- The device only offers back-of-hand protection, not touch protection.

## Establish programming mode





Make sure that the required operating mode is selected.

### Putting the radio receiver into programming mode by switching on the power





	(M) 1x	<p>Switch on the power.</p> <ul style="list-style-type: none"><li>▷ The LED next to the programming button flashes green and then flashes orange after 3 minutes.</li><li>▷ The receiver confirms.</li></ul> <p>▶ The radio receiver remains in programming mode for 15 minutes.</p>
---	--------	--









### Putting the radio receiver into programming mode with the programming button

		<p>Briefly press the programming button on the radio receiver.</p> <ul style="list-style-type: none"><li>▷ The LED next to the programming button flashes green and then flashes orange after 3 minutes.</li></ul> <p>▶ The radio receiver remains in programming mode for 15 minutes.</p>
---	---	--





With brand new products, devices from another installation or products that have been restored to factory settings, programming mode must be established beforehand (see Establishing programming mode).

		Bring the transmitter as close as possible to the receiver to be programmed.
		Press the programming button for 3 seconds when it is ready to program. The transmitter performs a search and the LED ring continuously changes colour. The transmitter then switches to receiver selection and selects the receiver with the best connection quality.  ▷ The receiver confirms.  If you do not receive confirmation from the required receiver, you can press the ▲/▼ button to toggle between the available receivers until the required receiver confirms. Pressing the ▲ button for 3 seconds confirms the receiver with the best connection quality.  ▷ The transmitter displays the current assignment status of the receiver via the LED ring.
		
<b>Assignment status</b>		
<b>Lights up yellow:</b>		The receiver is not yet part of the installation or is in the <b>as-delivered condition</b> .
<b>Lights up blue:</b>		The receiver is <b>not assigned to the selected channel</b> .
<b>Lights up green:</b>		The receiver is <b>assigned to the selected channel</b> .
<b>Lights up white:</b>		Centronic PLUS sensor selected.
<b>Lights up purple</b>		Centronic PLUS transmitter selected.
<b>Lights up red:</b>		No receiver located.

		<p>Select the desired channel by pressing the function key on the multi-channel hand-held transmitter.</p>
	<p>  1x  or     </p>	<p>Press the STOP button to change the assignment status of the selected receiver. If the receiver is not yet part of the installation, it will be added and assigned to the selected channel.</p> <ul style="list-style-type: none"> <li>▷ The receiver signals once to confirm the channel assignment, or signals twice to cancel the channel assignment.</li> <li>▷ The transmitter lights up accordingly to confirm the new assignment status.</li> </ul> <p>▶ The receiver is now part of the installation with the required channel assignment.</p>
 3s		<p>Then press the programming button for 3 seconds to change to normal mode.</p> <p>▶ The LED ring goes out.</p>

## Selection of the receiver for the setting mode

	<p>Bring the transmitter as close as possible to the required receiver.</p>
<p>● 3s</p>	<p>(M) 1x</p>  <p>Press the programming button for 3 seconds. The transmitter performs a search and the LED ring continuously changes colour. The transmitter then switches to receiver selection and selects the receiver with the best connection quality.</p> <ul style="list-style-type: none"> <li>▷ The receiver confirms.</li> </ul> <p>If you do not receive confirmation from the required receiver, you can press the ▲/▼ button to toggle between the available receivers until the required receiver confirms. Pressing the ▲ button for 3 seconds confirms the receiver with the best connection quality.</p> <ul style="list-style-type: none"> <li>▷ The transmitter displays the current assignment status of the receiver via the LED ring.</li> </ul>
<p><b>Assignment status</b></p>	
<p><b>Lights up yellow:</b></p>	<p>The receiver is not yet part of the installation or is in the <b>as-delivered condition</b>.</p>
<p><b>Lights up blue:</b></p>	<p>The receiver is <b>not assigned to the selected channel</b>.</p>
<p><b>Lights up green:</b></p>	<p>The receiver is <b>assigned to the selected channel</b>.</p>
<p><b>Lights up white:</b></p>	<p>Centronic PLUS sensor selected.</p>
<p><b>Lights up purple</b></p>	<p>Centronic PLUS transmitter selected.</p>
<p><b>Lights up red:</b></p>	<p>No receiver located.</p>

	<div data-bbox="301 69 377 109" style="border: 1px solid black; border-radius: 50%; padding: 2px; display: inline-block;"> <span style="font-size: 1.2em;">M</span> 1x         </div> <div data-bbox="301 139 346 238" style="border: 1px solid black; border-radius: 10px; padding: 5px; display: inline-block; margin-top: 5px;"> <div style="text-align: center;"> <span style="font-size: 0.8em;">▲</span>  <span style="font-size: 0.8em;">□</span>  <span style="font-size: 0.8em;">▼</span> </div> </div>	<p>Briefly press the programming button to change to the setting mode.</p> <ul style="list-style-type: none"> <li>▷ The receiver confirms.</li> <li>▷ The LED ring of the transmitter slowly pulses light blue.</li> <li>▷ The receiver now enters dead-man mode.</li> </ul> <p>▶ The setting mode is now active.</p> <p><b>i</b> If a receiver has not yet been added to the installation (LED ring lights up yellow), it will not be possible to select it in this way. The receiver must be added to the installation beforehand. See chapter “Programming CentronicPLUS transmitters”.</p>
--	--	--

## Changing direction of rotation via the transmitter



The direction of rotation can only be changed if no travel path has been set. The travel path will need to be deleted first if applicable, see chapter Deleting the travel path [▶ 28].

### Changing the direction of rotation with a CentronicPLUS transmitter







Select the required receiver as described in the chapter Selection of the receiver for the setting mode [▶ 22].

Press the ▲ or ▼ button.

- ▷ The shading solution runs in the desired direction.
- ▶ The running direction is OK. Now change back to normal mode, as described in the previous step.

If the shading solution runs in the wrong direction, the running direction must be changed. Proceed as follows:

 3s	 	First, press the programming button, then within 3 seconds also press the ▲ and ▼ button for 3 seconds. <ul style="list-style-type: none"><li>▷ The receiver confirms.</li><li>▷ The transmitter confirms with a red/blue rotation of the LED ring.</li></ul> Check the running direction again.
 3s		Then press the programming button for 3 seconds to change to normal mode. <ul style="list-style-type: none"><li>▶ The LED ring goes out.</li></ul>







When using the individual inputs, make sure that the direction of rotation corresponds to the radio operation.



## Adding additional transmitters to the installation



If installation data already exists for the transmitter being programmed, the procedure will be terminated. Termination is indicated by the red flashing of the LED ring. In this case, the transmitter will need to be restored to factory settings (see corresponding transmitter instructions).

 3s	 	<p>Press the programming button on an already programmed transmitter for 3 seconds. The transmitter performs a search and the LED ring continuously changes colour. The transmitter then switches to receiver selection and selects the receiver with the best connection quality.</p> <p>▷ The receiver confirms.</p>
		<p>Now press and hold the programming button for a new transmitter.</p> <p>▷ After 5 seconds, the LED rings on both transmitters start to fill in green.</p> <p>Continue pressing and holding the programming button.</p> <p>▷ Once the new transmitter has been added successfully, both transmitters flash green to confirm.</p> <p>► The transmitter has been added successfully.</p> <p><b>i</b> The programming process can be terminated at any time by pressing the <b>STOP</b> button on the transmitter that has already been programmed or by releasing the programming button.</p>

## Setting the travel path















Intermediate positions can only be fed back and programmed once the travel path has been set. A time of between 1 second and 10 minutes can be set as the travel path.



The set drive limit positions are not affected by changes to the programming of the travel path.

## Setting the travel path for roller shutter/awning

		Select the required receiver as described in the chapter Selection of the receiver for the setting mode [▶ 22].
		Close to the lower limit position.
	 	First press the programming button and, within 1 second, press the  button at the same time and hold both buttons down for 3 seconds. <ul style="list-style-type: none"><li>▶ The receiver confirms.</li><li>▶ The transmitter confirms by lighting up the lower third of the LED ring green.</li></ul>
		Then close to the upper limit position.
	 	First press the programming button and, within 1 second, press the  button at the same time and hold both buttons down for 3 seconds. <ul style="list-style-type: none"><li>▶ The receiver confirms.</li><li>▶ The transmitter confirms by lighting up the upper third of the LED ring.</li></ul>
		Then press the programming button for 3 seconds to change to normal mode. <ul style="list-style-type: none"><li>▶ The LED ring goes out.</li><li>▶ The reference route is set.</li></ul>

## Setting the travel path for venetian blind









	<p>Select the required receiver as described in the chapter Selection of the receiver for the setting mode [▶ 22].</p>	
	<p>Close to the lower limit position.</p>	
	 	<p>First press the programming button and, within 1 second, press the ▼ button at the same time and hold both buttons down for 3 seconds.</p> <ul style="list-style-type: none"> <li>▶ The receiver confirms.</li> <li>▶ The transmitter confirms by lighting up the lower third of the LED ring green.</li> </ul>
	<p>Then move out of the closed position (in setting mode) in the ▲ direction until the slats of the venetian blind are completely open (maximum tilt).</p>	
	 	<p>First press the programming button and, within 1 second, press the ▼ button at the same time and hold both buttons down for 3 seconds.</p> <ul style="list-style-type: none"> <li>▶ The receiver confirms and the maximum tilt of the venetian blind is stored.</li> <li>▶ The transmitter confirms by lighting up the lower third of the LED ring green.</li> </ul>
	<p>Then close to the upper limit position.</p>	
	 	<p>First press the programming button and, within 1 second, press the ▲ button at the same time and hold both buttons down for 3 seconds.</p> <ul style="list-style-type: none"> <li>▶ The receiver confirms.</li> <li>▶ The transmitter confirms by lighting up the upper third of the LED ring.</li> </ul>

 3s		<p>Then press the programming button for 3 seconds to change to normal mode.</p> <ul style="list-style-type: none"> <li>▶ The LED ring goes out.</li> <li>▶ The reference route is set.</li> </ul>
--	--	--

**i** If a travel path is set, the drive command will not be immediately ended when the respective limit position is reached. The corresponding relay remains switched on for an additional 60 seconds in order to ensure that the actual limit position is reached.

## Deleting the travel path

**i** When the travel path is deleted, the set intermediate positions and the tilt will be deleted as well.

	<p>Select the required receiver as described in the chapter Selection of the receiver for the setting mode [▶ 22].</p>	
	<p>Open/close the shading solution to a point between the limit positions.</p>	
 +  3s	 	<p>First press the programming button and, within 1 second, press the STOP button at the same time and hold both buttons down for 3 seconds.</p> <ul style="list-style-type: none"> <li>▶ The receiver confirms.</li> <li>▶ The transmitter confirms with red pulsing of the LED ring.</li> <li>▶ The reference route is now deleted.</li> </ul>
 3s		<p>Then press the programming button for 3 seconds to change to normal mode.</p> <ul style="list-style-type: none"> <li>▶ The LED ring goes out.</li> </ul>



## Intermediate positions I + II



The intermediate positions I + II are freely selectable positions for the shading solution between the two limit positions. Each travel button can be assigned one intermediate position. The travel path must be set before an intermediate position is set.

In venetian blind operation, the current slat tilt is saved as well as the intermediate positions I + II. The saved tilt is applied when moving to the respective intermediate position.

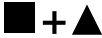
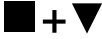
### Setting/modifying the desired intermediate position

	Open/close the shading solution to the desired intermediate position.	
 or 	 	Press the STOP button and, within 3 seconds, also press the desired travel button and hold the two buttons down. <ul style="list-style-type: none"><li>▷ The receiver confirms.</li><li>▷ The transmitter confirms by lighting up the upper/lower third of the LED ring light blue.</li></ul> <p>▶ The intermediate position is now saved.</p>





If several receivers are operated on the same channel, a specific receiver can also be selected beforehand. You can select the required receiver beforehand by following the description in the chapter Selection of the receiver for the setting mode [▶ 22].



## Travelling to the desired intermediate position

<p>2x ▲ or 2x ▼</p>		<p>Press the travel button for the desired intermediate position twice within one second.</p> <ul style="list-style-type: none"><li>▷ The transmitter confirms with a rotational movement of the LED ring from blue to turquoise.</li><li>▶ The shading solution travels to the intermediate position assigned to the travel button.</li></ul>
-----------------------------	---	--

## Deleting the desired intermediate position





<p>2x ▲ or 2x ▼</p>		<p>Move the shading solution to the intermediate position that is to be deleted.</p>
<p>■ + ▲ or ■ + ▼</p>	<p>(M) 2x</p>  	<p>Now press the STOP button and, within 3 seconds, also press the travel button assigned to the intermediate position and hold the two buttons down.</p> <ul style="list-style-type: none"><li>▷ The receiver confirms.</li><li>▷ The transmitter confirms by lighting up the upper/lower third of the LED ring light blue.</li><li>▶ The intermediate position is now deleted.</li></ul>

## Deleting the intermediate positions

 5s	 	<p>Press the STOP button twice within 1 second and then press and hold for 5 seconds.</p> <ul style="list-style-type: none"><li>▷ The receiver confirms.</li><li>▷ The transmitter confirms with red pulsing of the LED ring.</li></ul> <p>▶ The intermediate positions have now been deleted.</p>
---	--	--

## Manually adjusting the slat position

**i** Settings can only be adjusted using a SWCxxx PLUS hand-held transmitter.  
The receiver must be in blind mode.  
Make sure that the maximum tilt is already set; see chapter Setting/adjusting the maximum tilt (venetian blind operation).

		<p>Press and hold one of the two travel buttons until the required slat position is reached.</p> <ul style="list-style-type: none"><li>▷ The transmitter confirms by the LED ring filling or emptying yellow.</li></ul> <p>▶ The blind moves to the set slat position.</p>
	<p>A filled yellow LED ring indicates a completely opened blind.</p>	
	<p>An empty yellow LED ring indicates a completely closed blind.</p>	

## Switching actuator operating mode







### Connection (drive outputs)

The output ▲ is delivered connected. The direction of rotation can be changed, see corresponding chapter on changing the direction of rotation.

Function	Operation
Switching on	▲ / ▼ button on the transmitter
Switching off	■ button on the transmitter



### Setting a running time (optional)

In this operating mode, a running time can be programmed in the device. The radio receiver switches off automatically once the set time has elapsed. The time can be adjusted up to max. 10 minutes.

	Select the required receiver as described in Section of the receiver for the setting mode [▶ 22].
 	First press the programming button and, within 1 second, press the ▲ button at the same time and hold both buttons down for 3 seconds. <ul style="list-style-type: none"><li>▶ The consumer switches ON.</li><li>▶ The transmitter confirms by lighting up the upper third of the LED ring.</li></ul>
	Wait until the desired running time is reached.
 	Now briefly press the STOP button. <ul style="list-style-type: none"><li>▶ The consumer switches OFF.</li><li>▶ The transmitter confirms with blue pulsing of the LED ring.</li><li>▶ The transmitter doesn't confirm in setting mode.</li></ul> <p>▶ The running time is set.</p>









## Deleting the running time

	Select the required receiver as described in Selection of the receiver for the setting mode [▶ 22].
	 <p>First press the programming button and, within 1 second, press the STOP button at the same time and hold both buttons down for 3 seconds.</p> <ul style="list-style-type: none"><li>▶ The receiver confirms.</li><li>▶ The transmitter confirms with red pulsing of the LED ring.</li><li>▶ The running time has been deleted.</li></ul>

# Commissioning with a Centronic transmitter

## Explanation of symbols

Explanation of symbols	
	Up/retract button
	STOP button
	Down/extend button
	Programming button (on the transmitter)
	Programming button (on the radio receiver)
	Mode button (on the radio receiver)
	Receiver confirms once or multiple times by switching outputs or by the mode LED illuminating

## Programming the Centronic transmitter





### Caution



- Risk of injury due to electric shock.
- Connection may only be performed by a qualified electrician!
- The device only offers back-of-hand protection, not touch protection.

## Putting the radio receiver into programming mode

Putting the radio receiver into programming mode by switching on the power

		<p>Switch on the power.</p> <ul style="list-style-type: none"><li>▷ The LED next to the programming button flashes green.</li><li>▶ The radio receiver remains in programming mode for 3 minutes.</li></ul>
---	---	---

Putting the radio receiver into programming mode with the programming button

		<p>Briefly press the programming button on the radio receiver.</p> <ul style="list-style-type: none"><li>▷ The LED next to the programming button flashes green.</li><li>▶ The radio receiver remains in programming mode for 3 minutes.</li></ul>
---	---	--

## Programming the master transmitter



**Master transmitter means the first transmitter programmed in a receiver. In contrast to subsequently programmed transmitters, the master transmitter enables, among other things, the setting of the travel path and the programming or deleting of further transmitters. Any transmitter that has separate UP, STOP, DOWN buttons and a programming button can be a master transmitter.**

**If a master transmitter has already been programmed in the receiver, press the programming button on the new master transmitter for 10 seconds to delete the programmed master transmitter. Alternatively, use the already programmed master transmitter.**

● 3s	Ⓜ 2x	<p>Press the programming button of the transmitter for 3 seconds whilst in programming mode.</p> <ul style="list-style-type: none"> <li>▷ The receiver confirms.</li> <li>▶ Programming is now complete.</li> </ul>
------	------	---

## Programming additional transmitters



**In addition to the master transmitter, up to 15 further transmitters (of which a maximum of three can be sensors) can be programmed in the radio receiver.**

● 3s	Ⓜ 1x	<p>Press the programmed master transmitter's programming button for 3 seconds.</p> <ul style="list-style-type: none"> <li>▷ The receiver confirms.</li> </ul>
● 3s	Ⓜ 1x	<p>Now press the programming button of a new transmitter which has not yet been programmed in the radio receiver for 3 seconds. Doing so activates the programming mode of the radio receiver for a new transmitter for 3 minutes.</p> <ul style="list-style-type: none"> <li>▷ The receiver confirms.</li> </ul>
● 3s	Ⓜ 2x	<p>Now re-press the programming button of the new transmitter you wish to program for 3 seconds.</p> <ul style="list-style-type: none"> <li>▷ The receiver confirms.</li> <li>▶ The new transmitter has now been programmed.</li> </ul>

## Changing direction of rotation via master transmitter



The direction of rotation can only be changed if no travel path has been set. The travel path will need to be deleted first if applicable, see chapter Deleting the travel path with a Centronic transmitter [▶ 43].

Press the ▲ or ▼ button.

▶ The shading solution runs in the desired direction.

▶ The running direction is OK.

If the shading solution runs in the wrong direction, the running direction must be changed. Proceed as follows:

● + ▲ + ▼  
3s

Ⓜ 3x

First, press the programming button on the transmitter, then within 3 seconds also press the ▲ and ▼ button for 3 seconds.

▶ The receiver confirms.







Check the running direction again.

## Deleting transmitters





### Deleting individual transmitters





**The programmed master transmitter cannot be deleted. It can only be overwritten (see Programming the Centronic transmitter [▶ 35]).**

 3s	 1x	Press the programming button on the master transmitter for 3 seconds.  ▷ The receiver confirms.
 3s	 1x	Now press the programming button of the transmitter to be deleted for 3 seconds.  ▷ The receiver confirms.
 10s	 2x	Then re-press the programming button of the transmitter to be deleted for 10 seconds.  ▷ The receiver confirms.  ▶ The transmitter is now deleted from the receiver.

### Deleting all transmitters (except the master transmitter)

 3s	 1x	Press the programming button on the master transmitter for 3 seconds.  ▷ The receiver confirms.
 3s	 1x	Re-press the programming button on the master transmitter for 3 seconds.  ▷ The receiver confirms.

 10s	 2x	<p>Re-press the programming button on the master transmitter for 10 seconds.</p> <ul style="list-style-type: none"> <li>▷ The receiver confirms.</li> <li>▶ All transmitters (except the master transmitter) are now deleted from the receiver.</li> </ul>
--	---	--

## Overwriting the master transmitter

There are two ways to overwrite the master transmitter:



- Putting the radio receiver into programming mode by switching on the power
- Putting the radio receiver into programming mode with the programming button on the radio receiver

## Putting the radio receiver into programming mode by switching on the power





To ensure that the new master transmitter is programmed in the desired radio receiver only, all other receivers which are connected to the same power supply must be deactivated from the programming mode. To do so, after switching the power back on, execute a ▲, ▼ or stop command using the transmitter for the given radio receiver or press the programming button on the radio receiver.

		<p>Switch off the power supply to the radio receiver.</p>
	 1x	<p>Switch the power supply to the radio receiver back on after 10 seconds.</p> <ul style="list-style-type: none"> <li>▷ The receiver confirms.</li> <li>▷ The receiver goes into the programming mode for 3 minutes.</li> </ul>

 10s		<p>Now press the programming button of the new master transmitter for 10 seconds.</p> <ul style="list-style-type: none"> <li>▷ The receiver confirms.</li> <li>▶ The new master transmitter has now been programmed and the old master transmitter overwritten.</li> </ul>
---	--	--

## Putting the radio receiver into programming mode with the programming button on the radio receiver

	<p>Briefly press the programming button on the radio receiver.</p> <ul style="list-style-type: none"> <li>▷ The tubular drive is ready to program for 3 minutes.</li> </ul>	
 10s		<p>Now press the programming button of the new master transmitter for 10 seconds.</p> <ul style="list-style-type: none"> <li>▷ The receiver confirms.</li> <li>▶ The new master transmitter has now been programmed and the old master transmitter overwritten.</li> </ul>



## Setting the travel path with a Centronic transmitter



















Intermediate positions can only be fed back and programmed once the travel path has been set. A time of between 1 second and 10 minutes can be set as the travel path.

The set drive limit positions are not affected by changes to the programming of the travel path.

## Setting the travel path for roller shutter/awning

		Close to the lower limit position.
+  3s	1x	First press the programming button and, within 1 second, press the  button at the same time and hold both buttons down for 3 seconds.  ▷ The receiver confirms.
		Then close to the upper limit position.
+  3s	1x	First press the programming button and, within 1 second, press the  button at the same time and hold both buttons down for 3 seconds.  ▷ The receiver confirms.  ▶ The reference route is set.



## Setting the travel path for venetian blind

		Close to the lower limit position.
 +  3s	 1x	First press the programming button and, within 1 second, press the  button at the same time and hold both buttons down for 3 seconds.  ▷ The receiver confirms.
		Then move out of the closed position (in setting mode) in the  direction until the slats of the venetian blind are completely open (maximum tilt).
 +  3s	 1x	First press the programming button and, within 1 second, press the  button at the same time and hold both buttons down for 3 seconds.  ▷ The receiver confirms and the maximum tilt of the venetian blind is stored.
		Then close to the upper limit position.
 +  3s	 1x	First press the programming button and, within 1 second, press the  button at the same time and hold both buttons down for 3 seconds.  ▷ The receiver confirms.  ▶ The reference route is set.

## Deleting the travel path with a Centronic transmitter

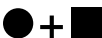

When the travel path is deleted, the set intermediate positions will be deleted as well.

	Open/close the shading solution to a point between the limit positions.
 10s	 2x First press the programming button and, within 1 second, press the STOP button at the same time and hold both buttons down for 10 seconds. <ul style="list-style-type: none"><li>▷ The receiver confirms.</li><li>▶ The reference route is now deleted.</li></ul>





## Intermediate positions I + II



The intermediate positions I + II are freely selectable positions for the shading solution between the two limit positions. Each travel button can be assigned one intermediate position. The travel path must be set before an intermediate position is set.

In venetian blind operation, the current slat tilt is saved as well as the intermediate positions I + II. The saved tilt is applied when moving to the respective intermediate position.

## Setting/modifying the desired intermediate position

	Open/close the shading solution to the desired intermediate position.
 or 	 1x Press the STOP button and, within 3 seconds, also press the desired travel button and hold the two buttons down. <ul style="list-style-type: none"><li>▷ The receiver confirms.</li><li>▶ The intermediate position is now saved.</li></ul>

## Travelling to the desired intermediate position

<p>2x ▲ or 2x ▼</p>	<p>Press the travel button for the desired intermediate position twice within one second.</p> <ul style="list-style-type: none"><li>▶ The shading solution travels to the intermediate position assigned to the travel button.</li></ul>
-----------------------------	--

## Deleting the desired intermediate position

<p>2x ▲ or 2x ▼</p>	<p>Move the shading solution to the intermediate position that is to be deleted.</p>
<p>■ + ▲ or ■ + ▼</p>	<p>(M) 2x</p> <p>Now press the STOP button and, within 3 seconds, also press the travel button assigned to the intermediate position and hold the two buttons down.</p> <ul style="list-style-type: none"><li>▷ The receiver confirms.</li><li>▶ The intermediate position is now deleted.</li></ul>

## Deleting the intermediate positions

<p>■ + ■ 10s</p>	<p>(M) 2x</p> <p>Press the STOP button twice within 1 second and then press and hold for 10 seconds.</p> <ul style="list-style-type: none"><li>▷ The receiver confirms.</li><li>▶ The intermediate position is now deleted.</li></ul>
----------------------	---

## Switching actuator operating mode



### Connection (drive outputs)

The output ▲ is delivered connected. The direction of rotation can be changed, see corresponding chapter on changing the direction of rotation.

Function	Operation
Switching on	▲ / ▼ button on the transmitter
Switching off	■ button on the transmitter

### Setting a running time (optional)

In this operating mode, a running time can be programmed in the device. The radio receiver switches off automatically once the set time has elapsed. The time can be adjusted up to max. 10 minutes.

	First press the programming button and, within 1 second, press the ▲ button at the same time and hold both buttons down for 3 seconds.  ▷ The consumer switches ON.
	Wait until the desired running time is reached.
	Now briefly press the STOP button.  ▷ The consumer switches OFF.  ▶ The running time is set.

### Deleting the running time

	First press the programming button and, within 1 second, press the STOP button at the same time and hold both buttons down for 10 seconds.  ▷ The receiver confirms.  ▶ The running time has been deleted.
---	--

# Additional functions with CentronicPLUS / Centronic

## Programming the run times



This function is available with all CentronicPlus EasyControl transmitters and with Centronic devices only equipped with "MemoControl" transmitters from the Becker range of control units. Both limit positions must be set before the Memo function is set.



This receiver can save a switching time for one ▲ and one ▼ cycle respectively. The drive command saved in this way is executed automatically every 24 hours when the Memo function is activated. Run times previously programmed are overwritten, irrespective of which transmitter the programming was carried out from.

	The tubular drive must be in the upper limit position to program the ▼ run time, and in the lower limit position to program the ▲ run time.
	Wait until the time at which the automatic drive command is to be carried out.
	At the desired time, press and hold the relevant travel button until the tubular drive briefly stops after approx. 6 seconds then continues to the limit position.  You can now release the travel button.  ► The receiver has saved the current time for this drive command.

## Deleting the run times with a CentronicPLUS transmitter





When deleting, both run times are always deleted.

 10s		Press the STOP button for 10 seconds.
		<ul style="list-style-type: none"><li>▷ The receiver confirms.</li><li>▷ The transmitter confirms with red pulsing of the LED ring.</li><li>▶ The run times are now deleted.</li></ul>

## Deleting the run times with a Centronic transmitter





When deleting, both run times are always deleted.

 10s		Press the STOP button for 10 seconds.
		<ul style="list-style-type: none"><li>▷ The receiver confirms.</li><li>▶ The run times are now deleted.</li></ul>

## Activating / deactivating the run times with a CentronicPLUS transmitter



The run times are activated and deactivated via the manual / automatic changeover at the transmitter.

	Press the STOP button for 3 seconds to display the current status.	
	<b>Automatic mode:</b>	The LED ring lights up <b>green</b> .
	<b>Manual mode:</b>	The LED ring lights up <b>red</b> .
	<b>Different modes:</b>	The LED ring lights up <b>yellow</b> .
	You can toggle between manual and automatic mode by pressing the STOP button for 5 seconds.	

## Activating / deactivating the run times with a Centronic transmitter



This function is only available with MemoControl transmitters from the Becker Centronic range of control units.

The Memo function is activated and deactivated via the slide switch. The last changeover to be performed is valid.

In the "☺" operating mode, this movement is repeated every 24 hours.

In the slide switch position "☹", no automatic drive commands will be executed.



## Restoring the factory settings for the radio programming



When resetting the radio programming, all programmed transmitters and installation data for CentronicPLUS, Centronic and the sensors will be deleted. Settings required for the particular operating mode will remain in place.



Press the programming button until the adjacent LED starts to flash red and then lights up green. Release the button as soon as the LED lights up green.

- ▶ The radio programming has been reset and the radio receiver switches to programming mode.

## Disposal



The crossed-out bin symbol on the product indicates that the device is subject to mandatory disposal separate from household waste. This product must be handed over to a collection point for electrical and electronic equipment at the end of its service life.

The packaging material must be disposed of properly.

## Technical data

Rated voltage	110-240 V AC/50-60 Hz
Switching current	$\mu$ 3A/110-240 V AC
Degree of protection	IP 20
Class of protection (dependent on correct assembly)	II
Permissible ambient temperature	-25 to +50°C
Roller shutter/awning running time	1 s to 10 min. (default: 2 min.)
Venetian blind running time	1 s to 10 min. (default: 3 min.)
Switching actuator running time	1 s to 10 min. (default: no running time)
Type of mounting	Device socket as per DIN EN 49073 / DIN EN 60670  surface mounted in appropriate surface mounted housing
Max. cable cross-section	1.5 mm <sup>2</sup>
Maximum emitted transmission power	$\leq$ 25 mW
Radio frequency	868.3 MHz
Factory setting	Roller shutters
Dimensions (W x H x D)	44 x 41 x 20 mm

The maximum transmitter range on and in the building is up to 25 m, and up to 350 m in the open.

## What to do if...?

Problem	Remedy
Tubular drive/receiver is not responding.	Insert a new battery/batteries into the hand-held transmitter.
	Make sure the battery/batteries is/ are correctly inserted in the hand-held transmitter.
	Reduce distance from receiver.
	Program transmitter.
	Check connection.
The LED ring on the hand-held transmitter lights up red when the receiver for the setting mode is selected.	Reduce distance from receiver.
	Check electr. connection of the receiver.
	Put the receiver into programming mode.
	Add the transmitter to the installation.
Tubular drive is running in the wrong direction.	Swap the ▲ and ▼ wires at the radio receiver.
	Change the direction of rotation via the transmitter.
Intermediate positions I/II have moved.	Set the travel path again and reprogram the intermediate positions I/II.
Tubular drive does not operate at the set switching time.	Changing from Manual to Automatic.
	If the slide switch of a Centronic transmitter is already at ⊖, switch it to ⊕ then back to ⊖.

Problem	Remedy
Set switching times change.	Frequent 230 V AC power cuts. Fluctuations in the 50 Hz mains frequency. Use a "TimeControl" transmitter and adjust the desired switching time there.
The required setting cannot be changed.	Make sure that the CentronicPlus transmitter is in setting mode, if necessary.

## Simplified EU declaration of conformity

Becker-Antriebe GmbH hereby declares that this radio control system complies with Directive 2014/53/EU.

The full text of the EU declaration of conformity is available at the following web address:

[www.becker-antriebe.com/ce](http://www.becker-antriebe.com/ce)



Subject to technical changes without notice.

### For UK-Markets:

The Declaration of Conformity can be provided upon request from Becker Motors Ltd., or can be downloaded on [www.beckermotors.co.uk](http://www.beckermotors.co.uk).











**BECKER**  
for you. forever.